

M2322

Darcy Flower House



NOTICE OF ASSEMBLE

Tips for Assembling Wood



Find the corresponding block number, use a knife in the connection point gently press, you can take out the wood.

Use a knife to smooth out the burr.

Or use sandpaper to smooth out the burr

Testing on LED function

Be sure to test the LED lights before making the lighting, note that the LED white wire to the negative, gray wire to the positive reference to the following figure operation test.

1



DO NOT contact the LED wire end direct to the battery cell.

2



Use the provide battery holder. Make sue the correct polarity.

How to assemble the battery holder

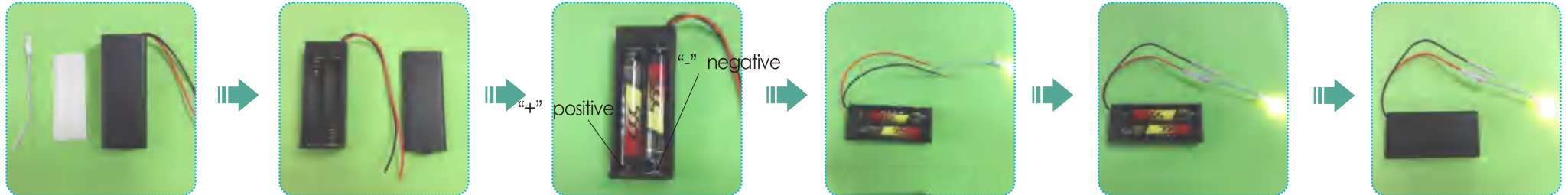

1. Material and tools needed:
- Battery holder, LED bulb, tape, screw driver and 2 pieces AAA size battery(not provided)

2. Use screw driver and take the lid off from the battery holder.

3. Insert the battery take notes on the polarity.

4. Connect the red wire to grey wire. Connect the black wire to white wire.

5. Wrap the exposed wire with the tapes.

6. Place the box lid and fastness with screw driver.

Symbol description used

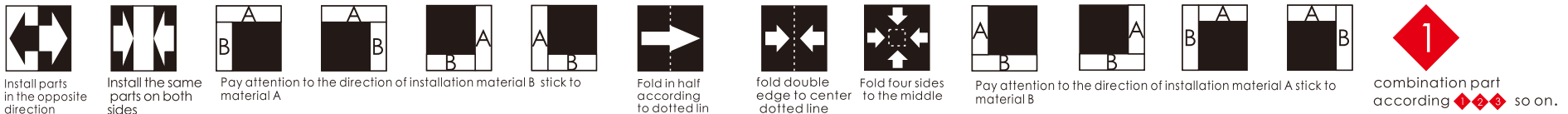

About the use of glue

Method for using glue:













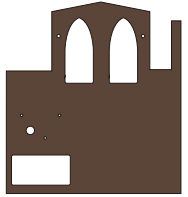



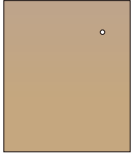

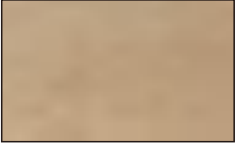

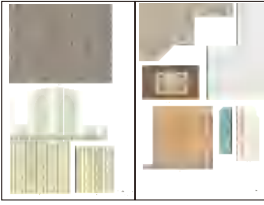
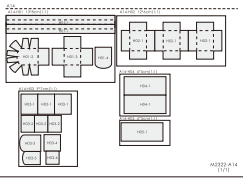
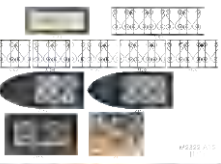
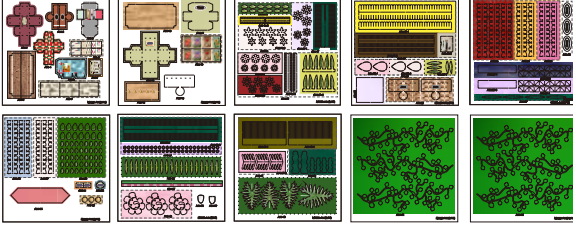

1. After applying the glue, let it dry for a few seconds before pasting.
2. Fix it slightly with your hands, and finally put it aside to dry;

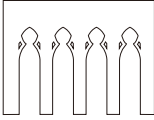
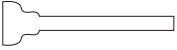



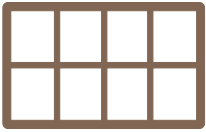

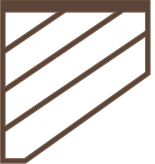











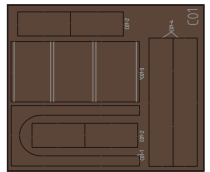
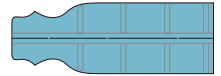



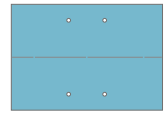



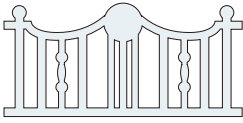
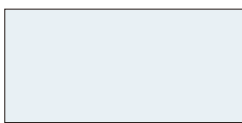
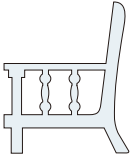

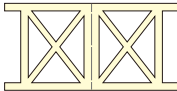
Tips:



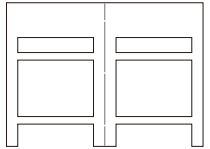

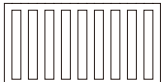





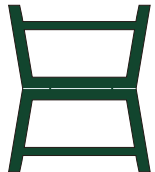





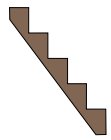
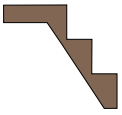

When pasting the plane printing paper, a piece of waste bank card or telephone card can be used to wipe evenly after the glue is smeared on the wood board, and then the printing paper is pasted to squeeze out the air inside.

Types of glue:



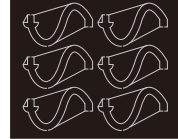
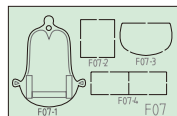
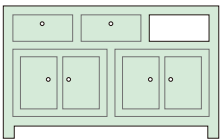
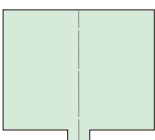
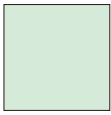

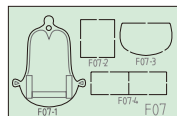





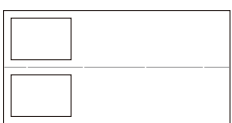
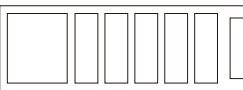







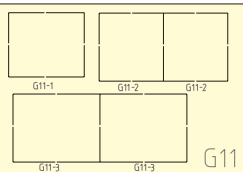
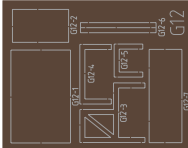



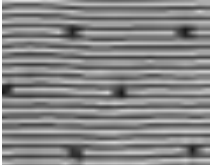



White latex: Used for adhering soft materials, such as wood and paper.
Alcoholic Glue: Used for adhering hard materials such as cloth, plastic, beads, wire, dust cover, etc.

<p>Bag A</p>	 <p>A01 MDF (dark brown edge) 22*17*0.5cm(1piece)</p>	 <p>A02 MDF(dark brown) 20.6*12.3*0.5cm(1piece)</p>	 <p>A03 MDF(dark brown) 22.8*20.8*0.5cm(1piece)</p>	 <p>A04 MDF (dark brown edge) 14.8*13.5*0.5cm(1piece)</p>	 <p>A05 MDF (dark brown edge) 20.3*12.3*0.5cm(1piece)</p>	 <p>A06 MDF(dark brown) 11.5*5*0.5cm(1piece)</p>
 <p>A07 MDF(wood color) 10*2.7*0.3cm(1piece)</p>	 <p>A08 MDF(wood color) 10*8.4*0.3cm(1piece)</p>	 <p>A09 MDF(dark green) 7.2*2*0.3cm(1piece)</p>	 <p>A10 MDF(dark green) 12.3*2*0.3cm(1piece)</p>	 <p>A11 MDF (dark green edge) 12.3*7.5*0.3cm(1piece)</p>	 <p>A12 Materials List & Instruction Manual</p>	 <p>A13 Printing paper (A3 2 sheets)</p>
 <p>A14 Template paper (A4 1sheet)</p>	 <p>A15 PVC(A5)</p>	 <p>A16 Double adhesive printing paper(10sheets)</p>			 <p>A17 Transparent adhesive (8*5cm)</p>	
<p>Bag B</p>	 <p>B01 Wooden grain (light brown) 8.7*3.7*0.3cm(1piece)</p>	 <p>B02 Plywood (light brown) 7*1.8*0.3cm(1piece)</p>	 <p>B03 Wooden grain (white) 6*4.5*0.3cm(1piece)</p>	 <p>B04 Wooden grain (white) 4.5*1.2*0.3cm(1piece)</p>	 <p>B05 Wooden grain (light brown) 6.6*3.8*0.3cm(1piece)</p>	 <p>B06 Wooden grain (light brown) 5.8*2.6*0.3cm(1piece)</p>
 <p>B07 Wooden grain (light brown) 7.8*3.4*0.2cm (2 pieces)</p>	 <p>B08 Wooden grain (light brown) 5.4*4.8*0.3cm(1piece)</p>	 <p>B09 Wooden grain (light brown) 8*5*0.3cm(1piece)</p>	 <p>B10 Wooden grain (dark brown) 8.5*3.7*0.3cm(1piece)</p>	 <p>B11 Wooden grain (dark brown) 6.5*5.9*0.3cm(1piece)</p>	 <p>B12 Wooden grain (dark brown) 5.9*3*0.3cm(1piece)</p>	 <p>B13 Wooden grain (dark brown) 6.5*1.1*0.3cm (1piece)</p>

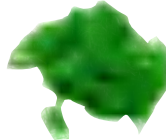

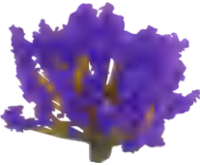





























 <p>B14 Wooden grain (dark brown) 2.5*2*0.3cm(1piece)</p>	 <p>B15 Round wood (dark brown) Φ=0.5*4.2cm(1strip)</p>	 <p>B16 Wooden grain (black) 3.1*2.8*0.2cm (1piece)</p>	 <p>B17 Wooden grain (black) 3.3*3.1*0.2cm (1piece)</p>	 <p>B18 Wooden grain (black) 4.1*3.1*0.2cm (2 pieces)</p>	 <p>B19 Wooden grain (black) 4.6*3.1*0.2cm(1piece)</p>	 <p>B20 Wooden grain (black) 8.4*3.1*0.2cm(1 piece)</p>
 <p>B21 Plywood (dark brown) 0.8*0.8*0.5cm (4 pieces)</p>	<p>Bag C</p>	 <p>C01 Wooden grain (dark brown) 13*11*0.2cm(1piece)</p>	 <p>C02 Wooden grain (blue) 8*2.8*0.2cm(1pieces)</p>	 <p>C03 Plywood (blue) 4*1*0.2cm(1piece)</p>	 <p>C04 Plywood (blue) 4*1.2*0.2cm(3 pieces)</p>	 <p>C05 Plywood (blue) 8*4*0.2cm(1piece)</p>
 <p>C06 Plywood (blue) 4.4*0.9*0.2cm(1piece)</p>	 <p>C07 Wooden grain (blue) 4*2.8*0.2cm(1piece)</p>	 <p>C08 Plywood (blue) 3.5*1.4*0.15cm(1 piece)</p>	 <p>C09 Plywood (blue) 1.4*1*0.15cm(2 pieces)</p>	 <p>C10 Plywood (blue) 3.5*0.8*0.15cm(1 piece)</p>	 <p>C11 Wooden grain (light gray) 6.3*3*0.2cm(1piece)</p>	 <p>C12 Plywood (light gray) 6.3*3*0.2cm(1piece)</p>
 <p>C13 Wooden grain (light gray) 4*3.3*0.2cm(2 pieces)</p>	 <p>C14 Wooden grain (light brown) 3*0.6*0.2cm(2 pieces)</p>	 <p>C15 Wooden grain (wood color) 9*6*0.3cm(1piece)</p>	 <p>C16 Wooden grain (creamy yellow) 4.6*2.3*0.2cm(1 piece)</p>	 <p>C17 Plywood (wood color) 5*2.5*0.2cm(1 piece)</p>	 <p>C18 Plywood (creamy yellow) 4.2*2.3*0.2cm(1 piece)</p>	<p>Bag D</p>
 <p>D01 Plywood (yellowish-brown) 4.8*2.8*0.3cm (1 piece)</p>	 <p>D02 Wooden grain (white) 5.2*3.8*0.2cm(1 piece)</p>	 <p>D03 Wooden grain (white) 4.1*0.9*0.2cm (1 piece)</p>	 <p>D04 Wooden grain (white) 4.1*2.2*0.2cm (1 piece)</p>	 <p>D05 Wooden grain (dark brown) 2.7*1.3*0.15cm (1 piece)</p>	 <p>D06 Wooden grain (dark brown) 2.7*1.3*0.5cm(1piece)</p>	 <p>D07 Round wood (white) Φ=0.5*1 cm(2 strips)</p>

 <p>D08 Wooden grain (creamy yellow) 3.2*3.1*0.2cm(2 pieces)</p>	 <p>D09 Wooden grain (dark green) 4.4*3.7*0.2cm(1piece)</p>	 <p>D10 Plywood(dark green) 3*1.6*0.2cm(1piece)</p>	 <p>D11 Wooden grain (dark brown) 9*8*0.15cm(1piece)</p>	 <p>D12 Wooden grain (dark brown) 2.5*1.2*0.3cm(4 pieces)</p>	<p>Bag E</p>  <p>E01 Round wood (dark brown) Φ=0.3*6cm(1strip)</p>	
 <p>E02 Round wood (dark brown) Φ=0.3*2.5cm(1strip)</p>	 <p>E03 Round wood (dark brown) Φ=0.3*1.5cm(1strip)</p>	 <p>E04 Plywood (light brown) 2.5*1*0.2cm(7 pieces)</p>	 <p>E05 Plywood (light brown) 2.5*2.5*0.2cm(1piece)</p>	 <p>E06 Wooden grain (light brown) 6.7*5.1*0.2cm(1piece)</p>	 <p>E07 Wooden grain (light brown) 4.5*4.1*0.2cm(2 pieces)</p>	 <p>E08 Wooden grain (black) 8.5*5.3*0.2cm(1 piece)</p>
 <p>E09 Wooden grain (black) 5.8*4.8*0.2cm(1 piece)</p>	 <p>E10 Wooden grain (black) 4.5*2.3*0.2cm(1 piece)</p>	 <p>E11 Wooden grain(black) 1.5*1.2*0.2cm(1piece)</p>	 <p>E12 Wooden grain (black) 1*0.8*0.2cm(1piece)</p>	 <p>E13 Wooden grain (black) 2.2*0.6*0.2cm (2 pieces)</p>	 <p>E14 Wooden grain (black) 1*1*0.5cm(1piece)</p>	 <p>E15 Wooden grain (black) 4.5*3.7*0.2cm (1 piece)</p>
<p>Bag F</p>  <p>F07 Wooden grain (mint green) 4.5*3*0.15cm (1piece)</p>	 <p>F01 Wooden grain (mint green) 5.7*3.5*0.2cm(1piece)</p>	 <p>F02 Wooden grain (mint green) 4*3.5*0.2cm(1piece)</p>	 <p>F03 Wooden grain (mint green) 1.6*0.7*0.2cm(1piece)</p>	 <p>F04 Plywood (mint green) 1.4*1.4*0.15cm (1piece)</p>	 <p>F05 Wooden grain (mint green) 1.4*1.4*0.5cm(1piece)</p>	 <p>F06 Wooden grain (dark brown) 6*4*0.15cm(1piece)</p>
 <p>F07 Wooden grain (mint green) 4.5*3*0.15cm (1piece)</p>	 <p>F08 Wooden grain (light brown) 2*1.5*0.2cm(1piece)</p>	 <p>F09 Wooden grain (light brown) 1.4*0.5*0.2cm(1piece)</p>	 <p>F10 Wooden grain (yellowish-brown) 3.2*2.8*0.2cm(2 pieces)</p>	 <p>F11 Wooden grain (yellowish-brown) 2.5*0.5*0.2cm(2 pieces)</p>		



<p>Bag G</p>	 <p>G01 Wooden grain (white) 6*3*0.2cm(1piece)</p>	 <p>G02 Wooden grain (white) 6.5*2.2*0.2cm(1piece)</p>	 <p>G03 Wooden grain (white) 6.5*2.2*0.2cm (1piece)</p>	 <p>G04 Plywood(white) 2.3*1.9*0.2cm(1piece)</p>	 <p>G05 Plywood(white) 1.8*1.5*0.2cm(1piece)</p>	 <p>G06 Wooden grain (dark brown) 2.9*2.8*0.2cm(1piece)</p>
 <p>G07 Wooden grain (black) 1.4*0.9*0.2cm(2 pieces)</p>	 <p>G08 Wooden grain (black) 1.8*1.7*0.2cm (2 pieces)</p>	 <p>G09 Wooden grain (dark brown) 6.5*3*0.15cm(1piece)</p>	 <p>G10 Wooden grain (dark brown) 2.4*1.9*0.3cm(1piece)</p>	 <p>G11 Wooden grain (creamy yellow) 6.5*4.5*0.15cm(1piece)</p>	 <p>G12 Wooden grain (dark brown) 7.5*6*0.2cm(1piece)</p>	<p>Bag H</p>
 <p>H01 Linen(white) 13*8cm(1piece)</p>	 <p>H02 Linen(green) 13*6cm(1piece)</p>	 <p>H03 Non-woven fabric (white) 9*7cm(1piece)</p>	 <p>H04 Cloth (black&white) 6*5cm(1piece)</p>	 <p>H05 Cloth(khaki) 6*3cm(1piece)</p>	 <p>H06Iron wire(green) 100cm(2 strips)</p>	 <p>H07 Iron wire(gold) 15cm(1strip)</p>
 <p>H08 Iron wire(black) 50cm(1strip)</p>	 <p>H09 Paper rope (brown) 30cm(1 strip)</p>	 <p>H10 Cotton thread (white) 50cm(1 strip)</p>	 <p>H11 Cotton(white) (some)</p>	<p>Bag J</p>	 <p>J01 Moss(green) (some)</p>	 <p>J02 Grass powder (green)(some)</p>
 <p>J03 Plant (green)(2 pieces)</p>	 <p>J04 Plant (chartreuse)(1piece)</p>	 <p>J05 Simulation flowers (purple)(1piece)</p>	 <p>J06 Simulation flowers (red)(2 pieces)</p>	 <p>J07 Simulation flowers (blue)(1piece)</p>	 <p>J08 Simulation flowers (Pink Purple)(2 pieces)</p>	 <p>J09 Plastic bead (grey)(1piece)</p>



 J10 Wooden bead (wood color)(2 pieces)	 J11 Finished vase (white)(1piece)	 J12 Finished small vase (white)(1piece)	 J13 Resin (black-white)(1piece)	 J14 Plastic flowerpot (orange)(1piece)	 J15 Plastic flowerpot (rose) (1piece)	 J16 Plastic flower beds (white)(1piece)
Bag K	 K01 Flower pot wood bead (wood color)(2 pieces)	 K02 Flower pot wood bead (dark brown)(2 pieces)	 K03 Small flowerpot wood bead (blue)(1piece)	 K04 Flower pot wood bead (dark green)(1piece)	 K05 Wooden bead (white)(1piece)	 K06 Round wooden bead (black)(1piece)
 K07 Wooden bead (white)(4 pieces)	 K08 Wooden bead (yellow)(3 pieces)	 K09 Wooden bead (red)(3 pieces)	 K10 Wooden bead (pink)(3 pieces)	 K11 Plastic bead (transparent)(3 pieces)	 K12 Round Plastic bead (transparent)(1piece)	 K13 Plastic bead (blue)(2 pieces)
 K14 Plastic bead (transparent)(5 pieces)	 K15 Beads(yellow) (11pieces)	 K16 Iron bead (bronze)(3 pieces)	 K17 Iron bead(silver) (1piece)	 K18 Eight leaf receptacle (gold)(1piece)	 K19 Iron bead (gold)(10 pieces)	 K20 Scissors(gold) (1piece)
 K21 Plastic bead (white)(1piece)	Bag L		 L01 LED light (Warm white light) (5 lamps)	 L02 AAA battery box (black)(1piece)	 L03 Sand paper (grey)(1piece)	 L04 Tape(white) (2 pieces)

Assembly The Frame 1

Tip: When pasting panels, if the printing paper exceeds the size of the wooden board, please cut off the excess

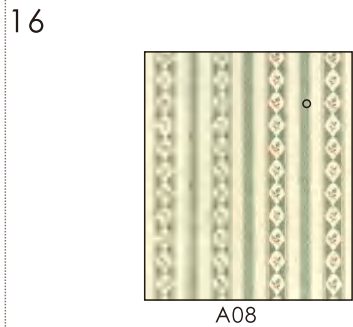
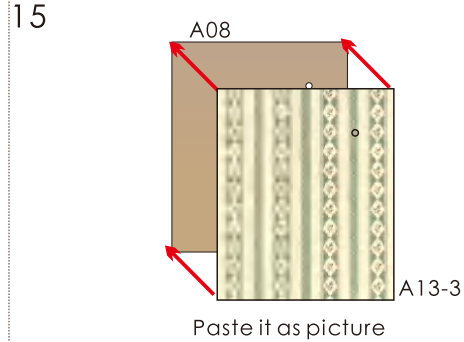
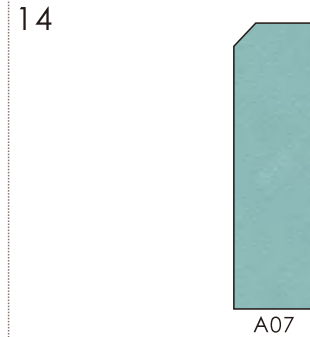
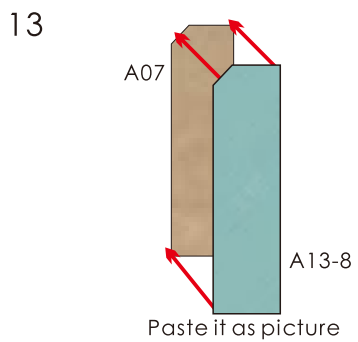
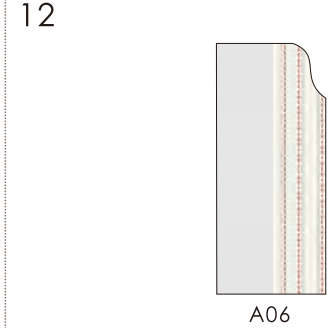
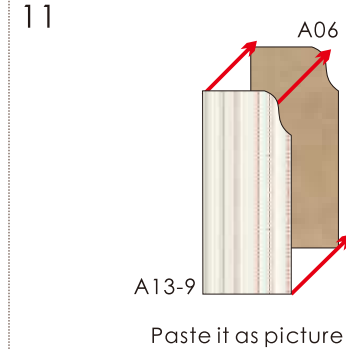
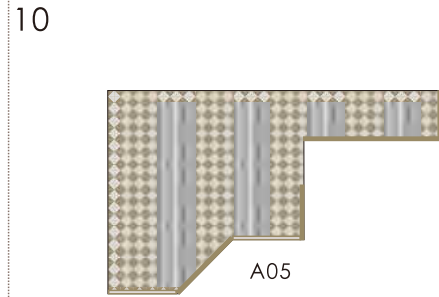
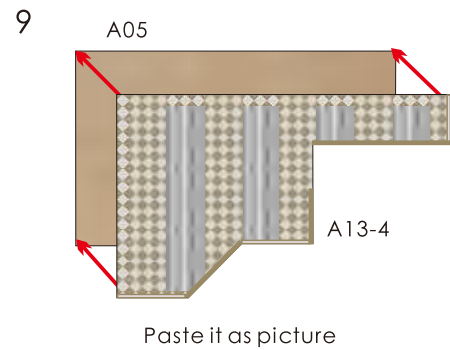
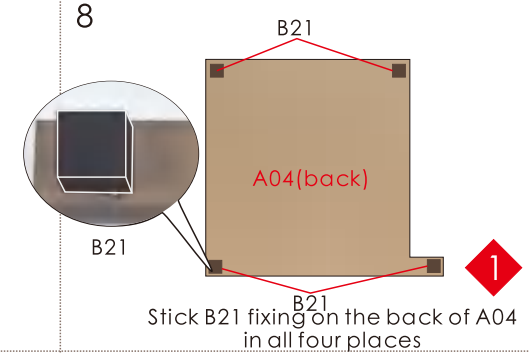
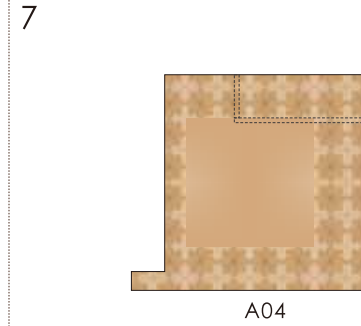
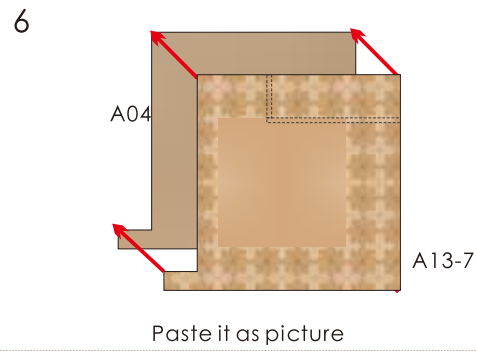
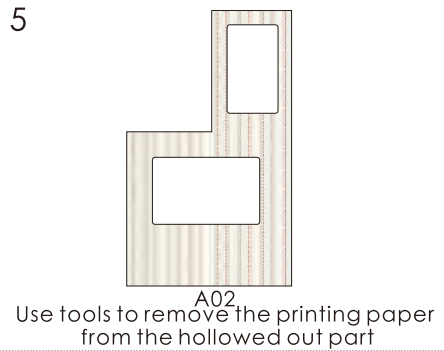
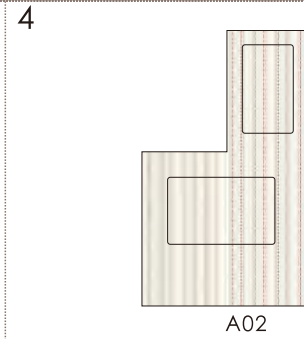
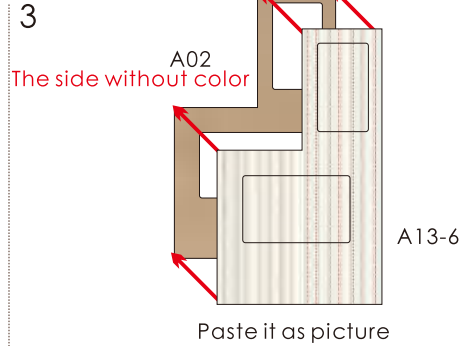
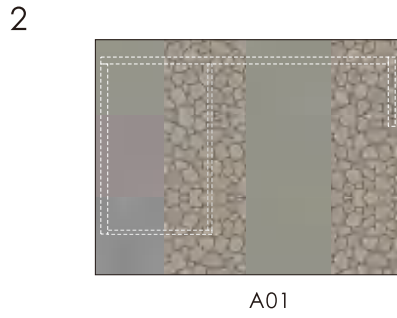
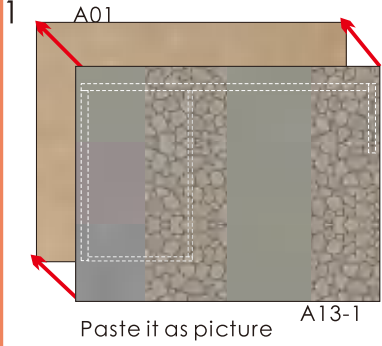

17



A13-5

Paste it as picture

18



A11

19

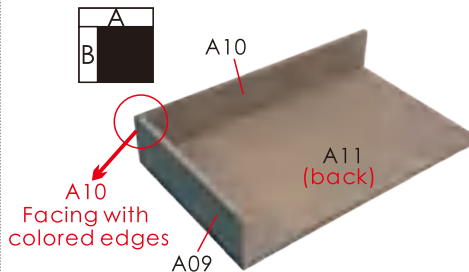

Paste it as picture

20



Vertical display

Before production, cut out all A15 first

Window frame production

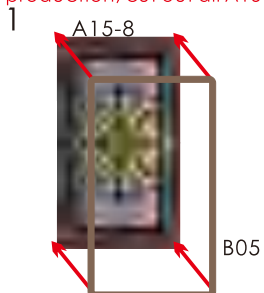

Paste it as picture

2

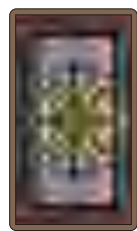

B05

3

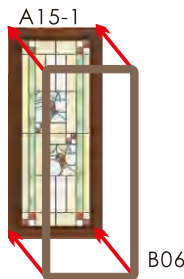

Paste it as picture

4



B06

5

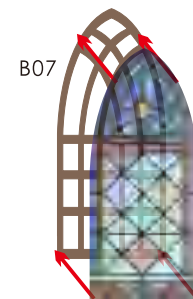

To paste as shown in the picture, 2 sets need to be completed

6



Complete as shown

7

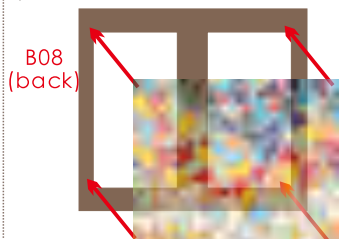

A15-9

Tip: Stick A15-9 onto the back of A08

8



B08(back)

Pay attention to the direction of the rounded corners

9



B08(front)

Pay attention to the direction of the rounded corners

Guardrail production

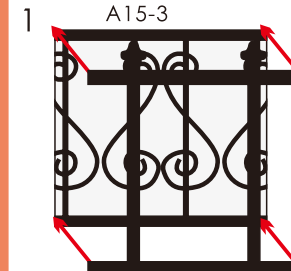

B16

Paste as shown in the picture, B16 on top

2



B16

3

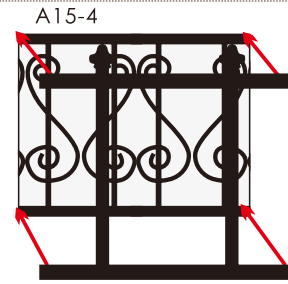

B17

Paste as shown in the picture, B17 is on top

4



B17

5

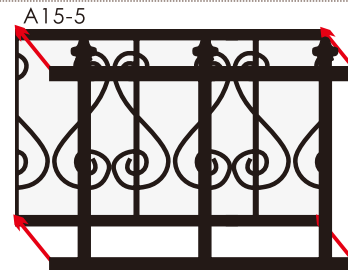

B18

Paste as shown in the picture, B18 is on top, 2 sets need to be completed

6



Complete as shown

7



B19

Paste as shown in the picture, B19 is on top

8



B19

9



B20

Paste as shown in the picture, B20 on top

10



B20

Wall lamp production

Before production, cut out A17-3 first. Before using the LED light, please test whether it can light up before using it

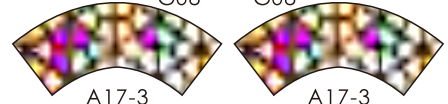
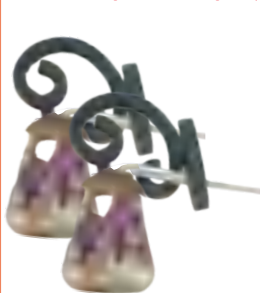

1

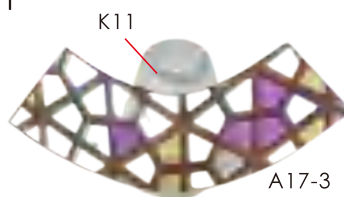

A17-3

Tip: Before pasting, peel off the A17-3 sticker and take the transparent part to use

A17-3 Paste and fix around K11

2

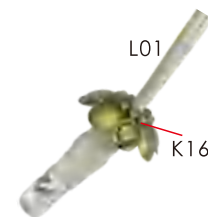

L01

K16

L01 penetrates into K16

3



Assembling and fixing as shown in the diagram, two sets need to be completed

4



G08

G07

Fixed as shown in the picture

Assembly The Frame 2

1

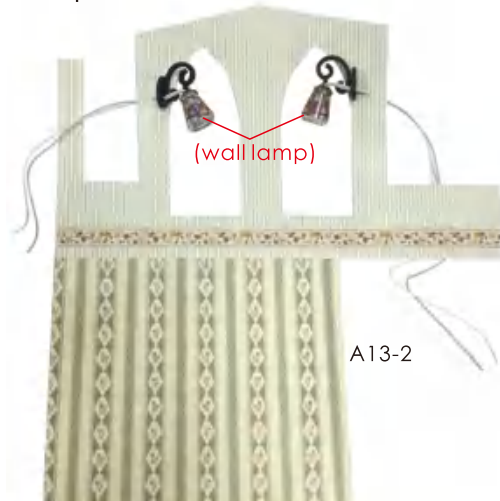

(wall lamp)

A13-2

Tip: For A13-2, it is necessary to remove the printing paper from the window frame where the lines are drawn. Cut out A13-2 first, then insert it into the wall lamp

2

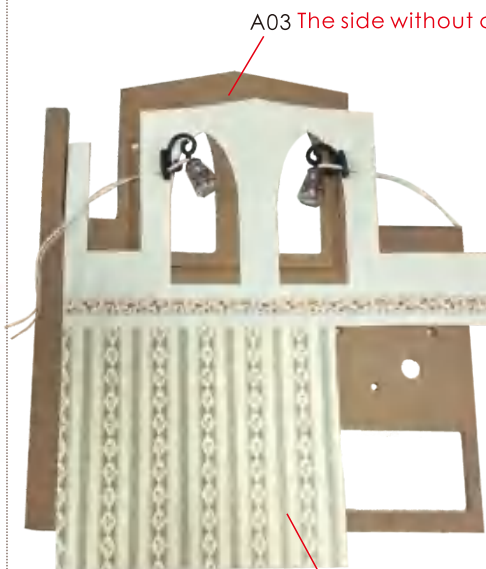

A03 The side without color

A13-2

Roughly align first

3

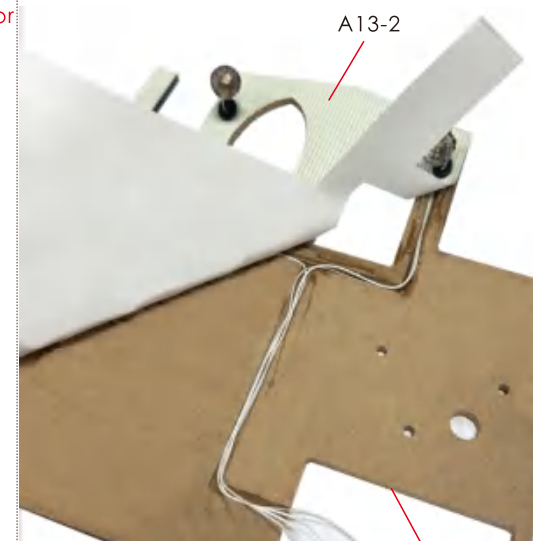

A13-2

A03

Route the wiring as shown in the diagram, place the light wire in the light groove, and adjust it while pasting

5



(wall lamp)

Fixed as shown in the diagram, 2 sets need to be completed

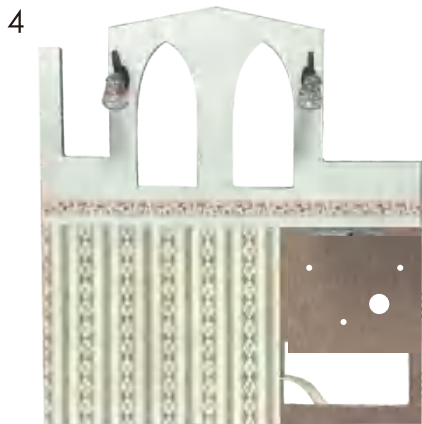

The effect of pasting completion is shown as follows

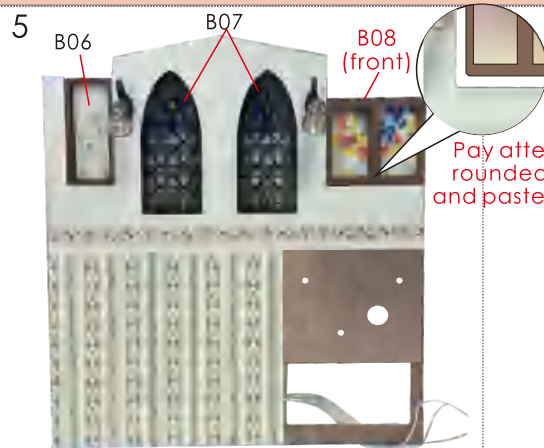

As shown in the figure, snap in B06, B07, and B08

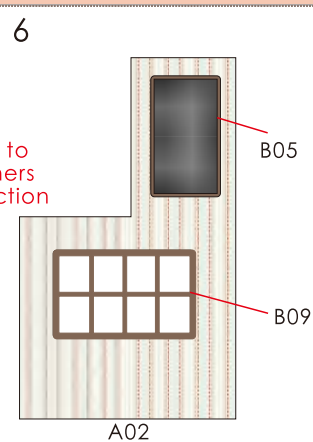

As shown in the figure, snap in B05 and B09



Fixed pasting

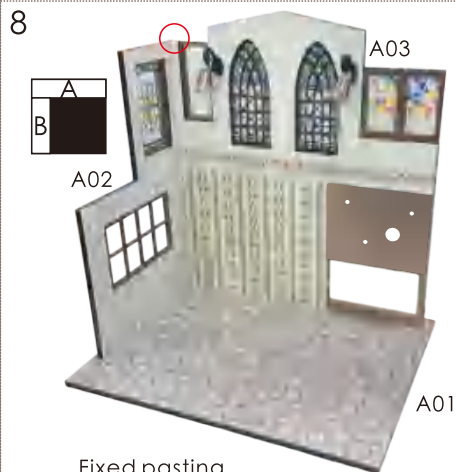

Fixed pasting



Place as shown in the picture, fix and paste



Place as shown in the picture, fix and paste

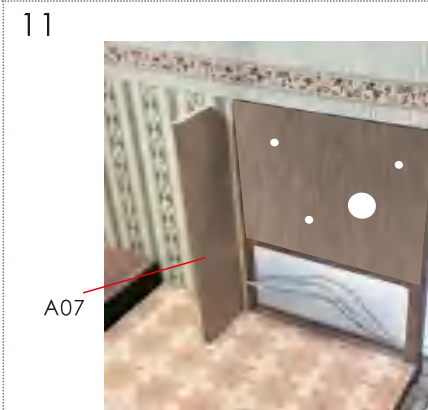

Fixed pasting

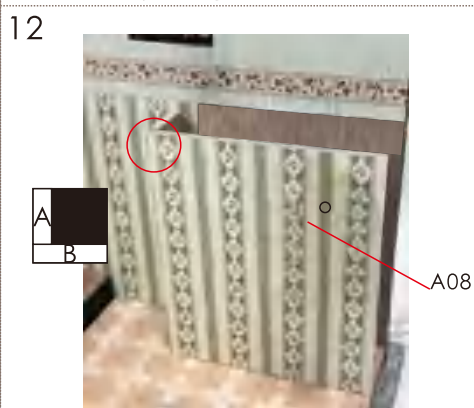

Fixed pasting



Fixed pasting

According to personal preferences, the following components can be selected for production

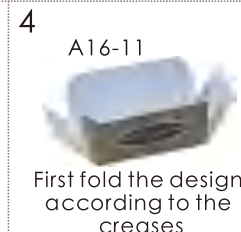
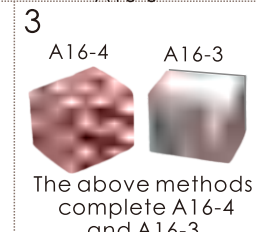
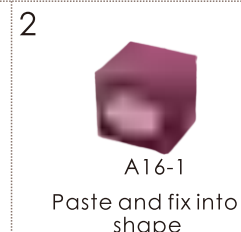
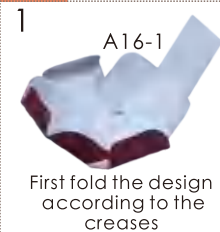
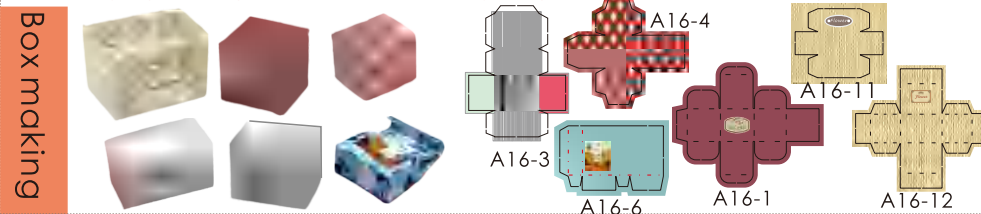

5



A16-11

Paste and fix into shape

6



A16-12

First, follow the above methods to complete the pasting process

7

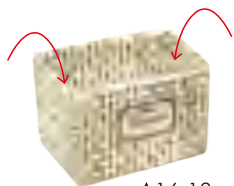

A16-12

Paste it inside again

8



A16-6

First fold the design according to the creases

9



A16-6

Paste bottom again

10



A16-6

11



A16-6

Squeeze on both sides, slightly curl up

Freshness



According to personal preferences, the following components can be selected for production

J06

J06

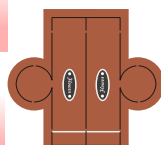

A16-2

1

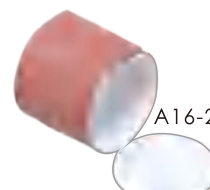

A16-2

paste

2



A16-2

Paste bottom

3



J06

Assembled as shown in the picture, 2 pots need to be completed

Blue wall cabinet

Before production, cut out A17-2 first

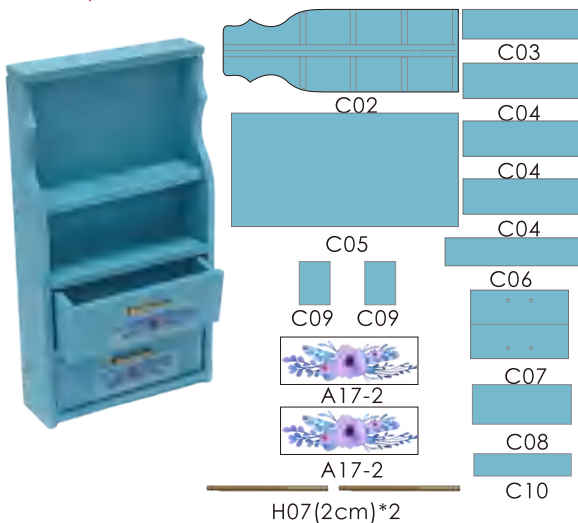

1

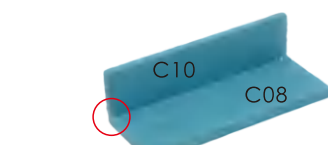

C10

C08



Paste and fix

2

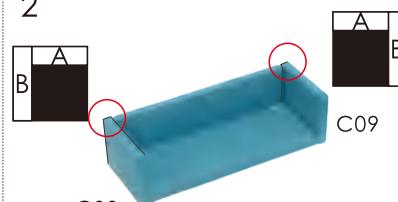

C09

Paste and fix on both sides

3

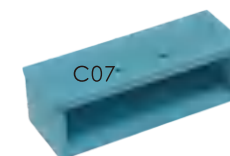

C07

Paste and fix

4

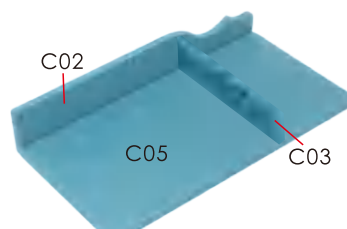

C02

C05

C03

Place as shown in the picture, paste and fix it

5

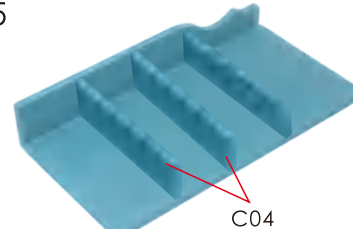

C04

Place as shown in the picture, paste and fix it

6

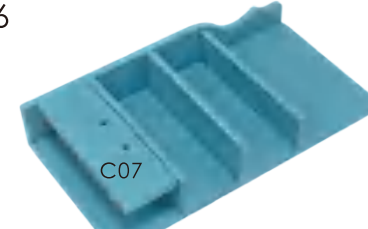

C07

Place as shown in the picture, paste and fix it

7

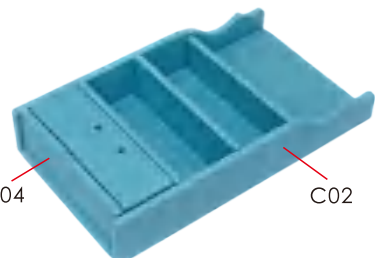

C04

C02

Place as shown in the picture, paste and fix it

8



C06

Paste and fix

9

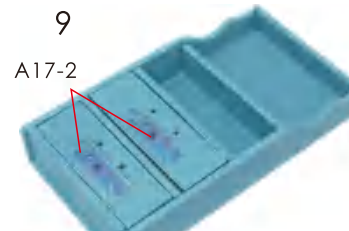

A17-2

Tip: Before pasting, peel off the A17-2 sticker and take the transparent part to use

10

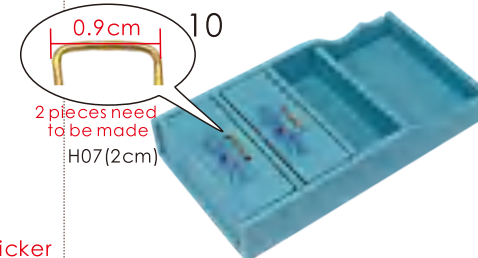

0.9cm
2 pieces need to be made
H07(2cm)

Tip: Bend H07 before pasting

11



Parts can be placed according to personal preferences

Brown wall cabinet

Before production, first remove the wooden particle board of C01



5

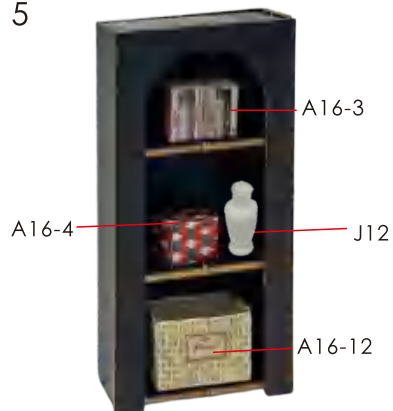

Parts can be placed according to personal preferences

Before production, cut out all the fabric materials and remove the wood particle board used in C15

Sofa

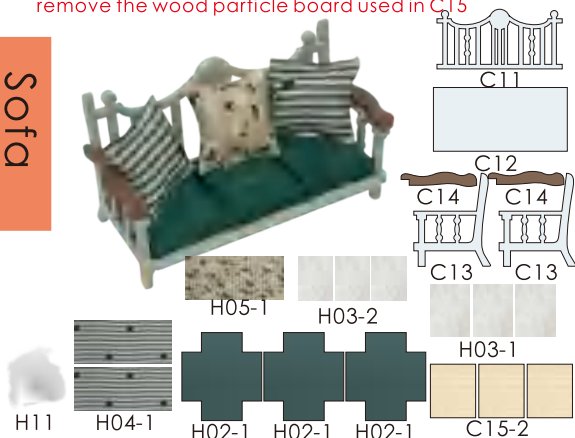

1

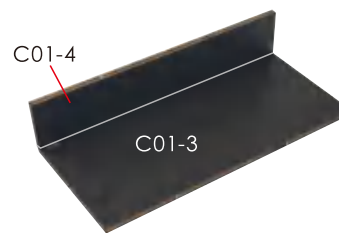

2

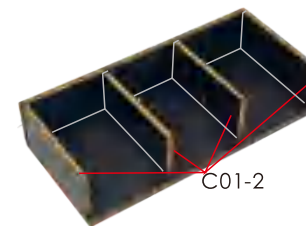

3

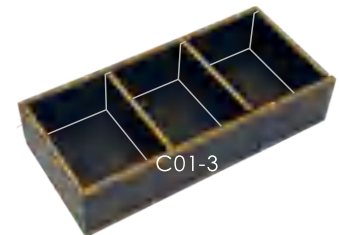

4

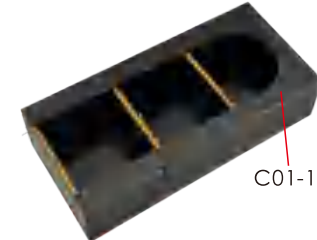

1

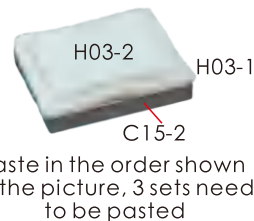

2

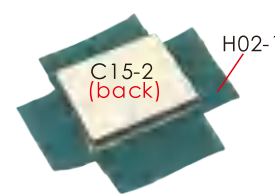

3



4

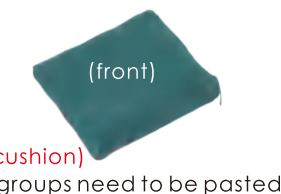

5

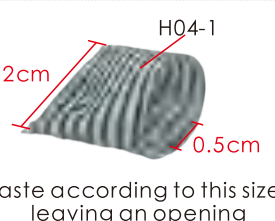

6

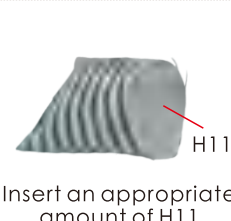

7



8

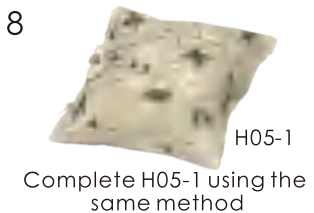

9

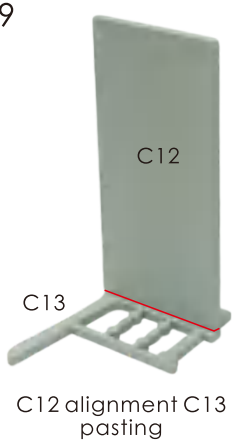

10

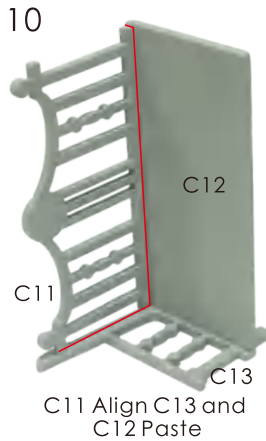

11



12



13

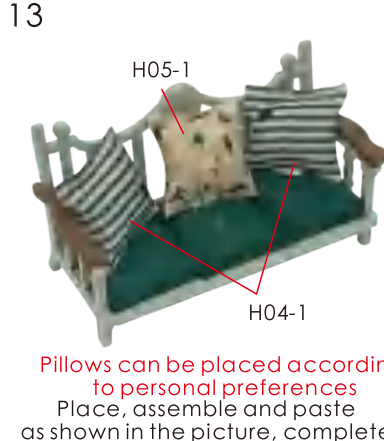

Tea table

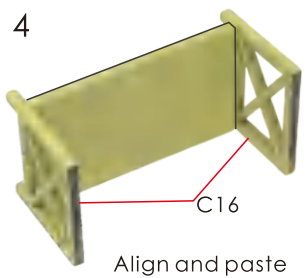
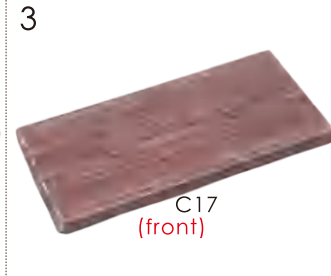
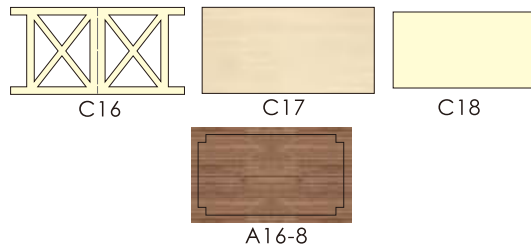

Tulip

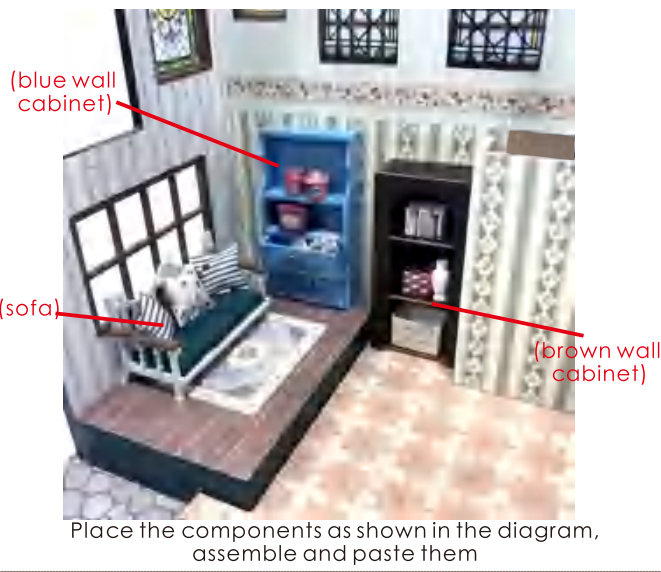
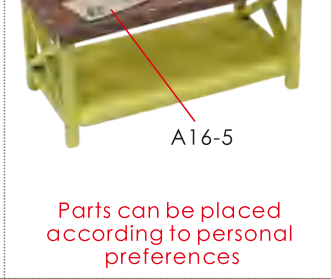
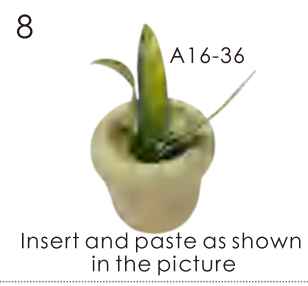
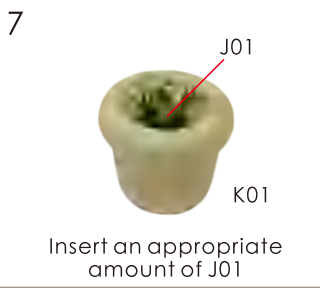
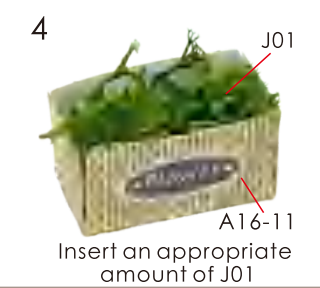
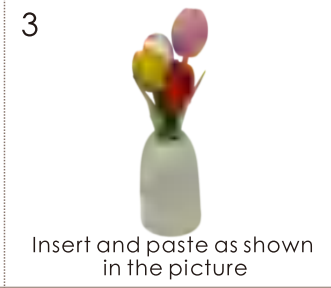
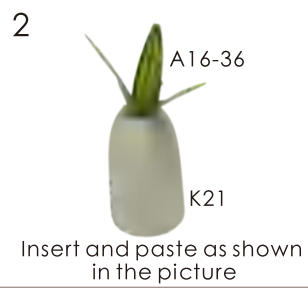
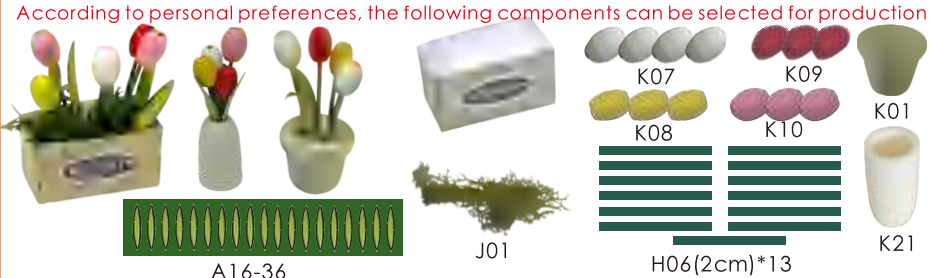

Single headed rose

According to personal preferences, the following components can be selected for production

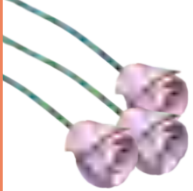

- A16-40
- H06(2.5cm)
- H06(2.5cm)
- H06(2.5cm)

1

A16-40

H06(2.5cm)

Roll up and paste from inside

2

3 flowers need to be completed

Staging

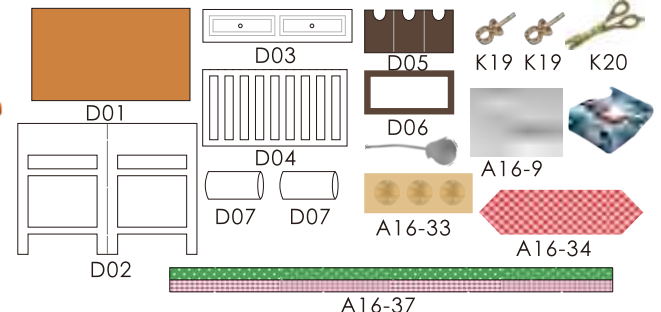

1

D02

D04

Align and paste

2

D03

Align and paste

3

D01

Align and paste

4

K19

paste

5

D05

D06

6

A16-33 (Wooden box)

7

A16-37

D07

(silk ribbon)

A16-37 wrapped and pasted on D07

8

(silk ribbon)

(Wooden box)

(rose)

A16-34

A16-9

Parts can be placed according to personal preferences

9

A16-6

K20

Parts can be placed according to personal preferences

Before production, first remove the wood particle board used in D11

Shelf 1

D08

D08

D11-1

D11-2

1

D08

D08

D11-2

Paste and fix

2

D11-1

Paste and fix

Shelf 2

D09

D10

1

D09

D09

D10

Paste and fix

2

Vertical display

Flower box

Before production, first remove the wood particle board used in D11



4

A16-26 **3**

Paste as shown in the picture, complete

5

D11-5, D11-6, D11-7

The production method is the same as above

6

A16-26 **4**

Paste as shown in the picture, complete

2

A16-41-1

To organize this design, 2 pieces need to be completed

3

A16-41-2

Roll up all and paste

4

A16-41-1

Paste and fix, 2 pieces need to be completed

Saffron

1

A16-41-1, A16-41-2

According to personal preferences, the following components can be selected for production

A16-41-1, A16-41-2

1

A16-41-1

Roll up and paste

5

K04

(Saffron potted plant)
Place and paste

Cactus

1

A16-42

Fold in half

2

(cactus)

Fold and paste, complete 3 sets of cacti

1

J01 (some)

4

3

J01 (some)

3

5

J08

Trimmed J08 inserted into the wood hole

J08 Cut out the desired length

Rose potted plant

J01 (some)

J01

(rose)

2

(saffron), (cactus)

4

J03

J03 Cut out different lengths

1

J01 (some)

Insert an appropriate amount of J01

2

(rose)

(Rose potted plant)

Morning glory

According to personal preferences, the following components can be selected for production

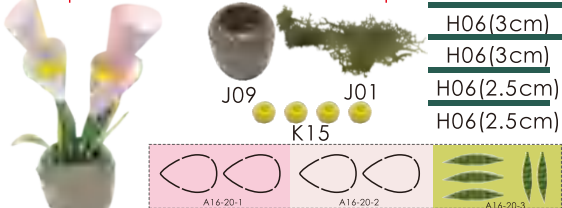

A16-20

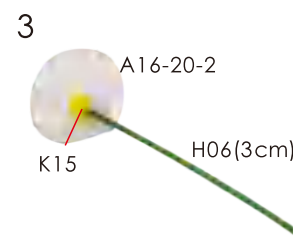

Paste it as picture

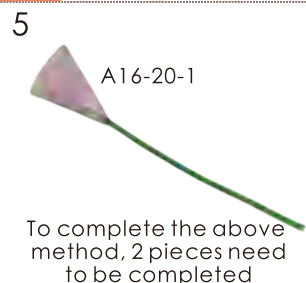
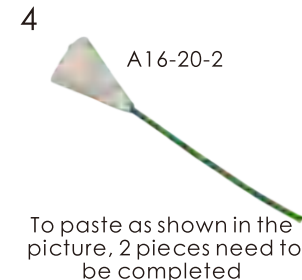

Chrysanthemum

According to personal preferences, the following components can be selected for production

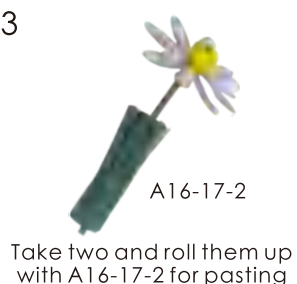
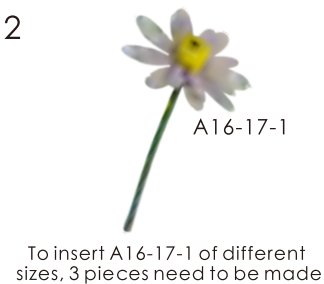
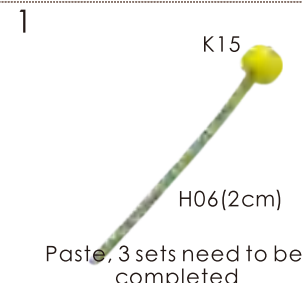

First floor flowers

According to personal preferences, the following components can be selected for production

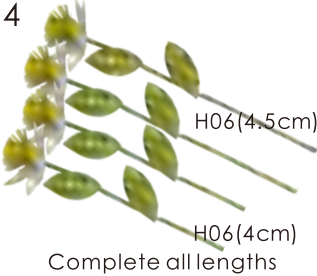
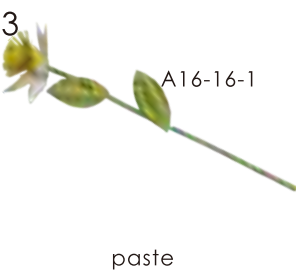
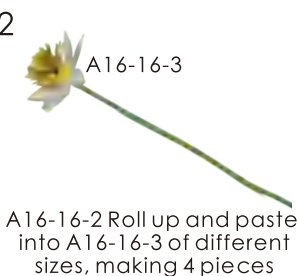
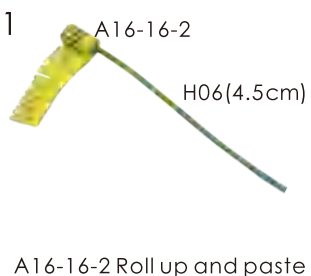
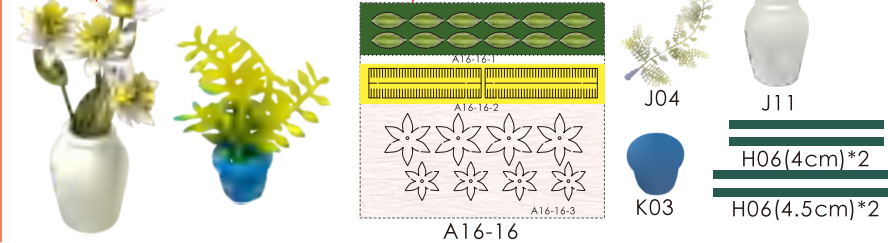

According to personal preferences, the following components can be selected for production

Hyacinth

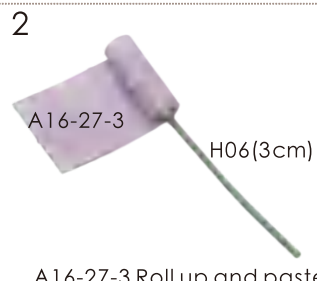

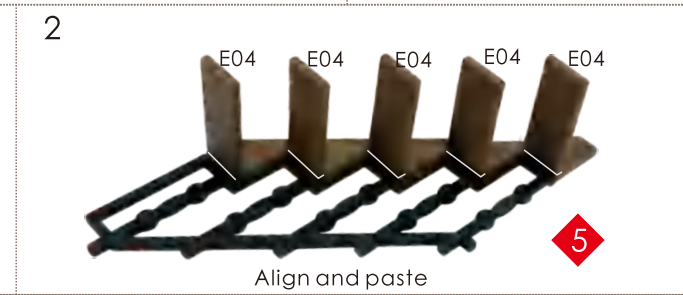
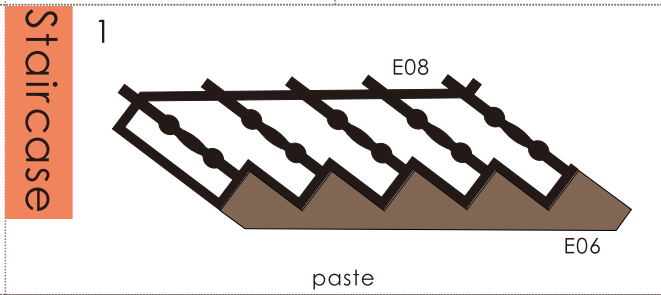
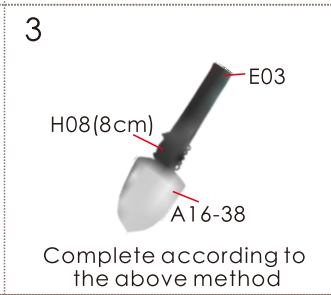
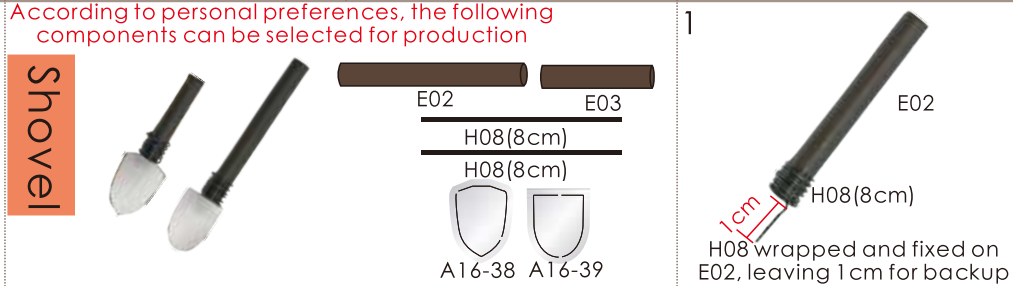
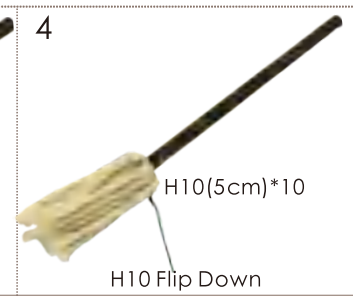
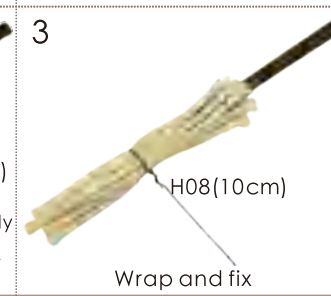
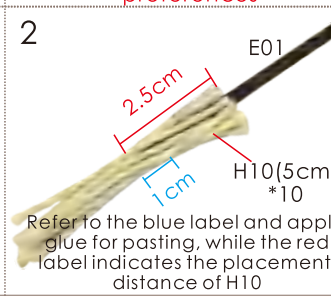
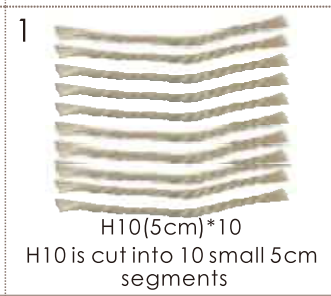
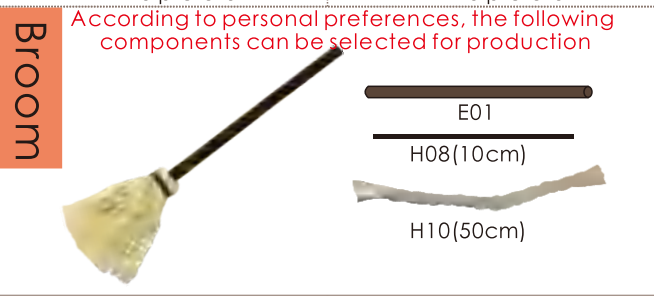
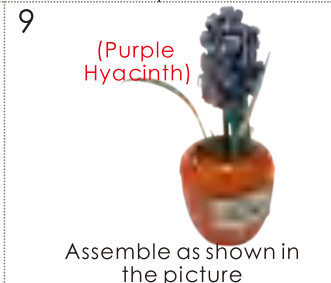
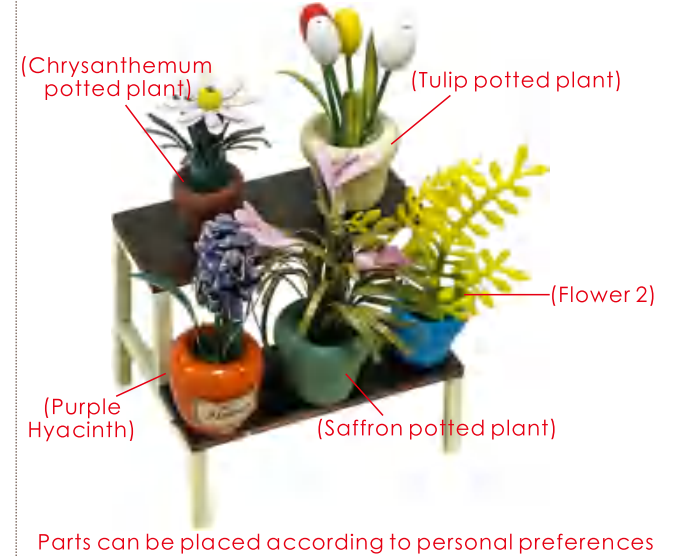
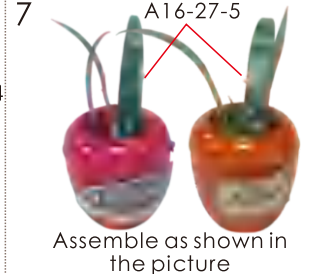
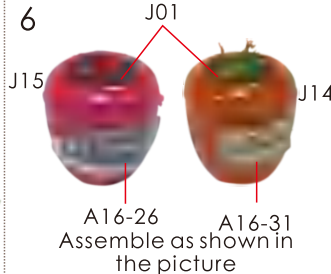

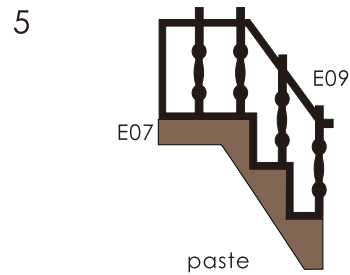
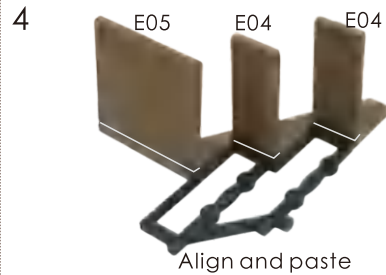
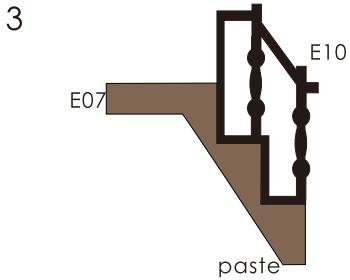

Oil lamp

Before using the LED light, please test whether it can light up before using it

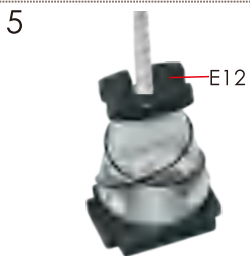
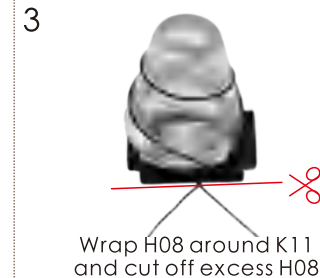
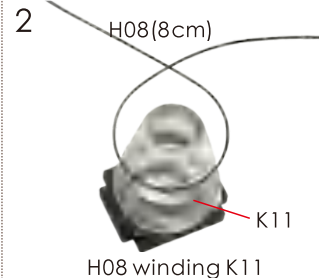
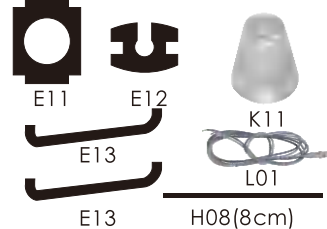

Pendant

Before production, first remove the wood particle board used in E15, which includes a spare part. Before using the LED light, please test whether it can light up before using it

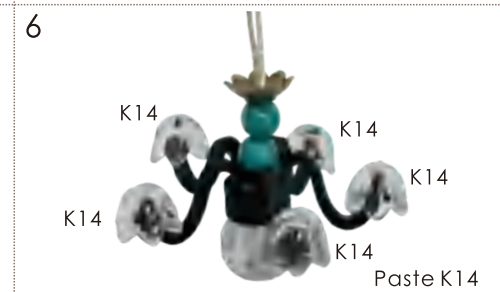
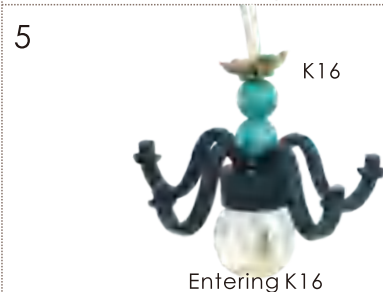
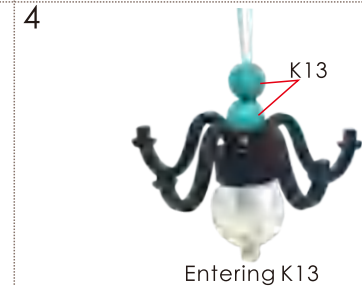
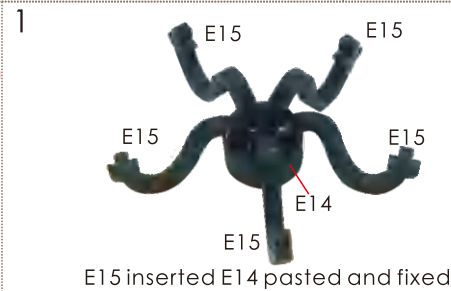

7

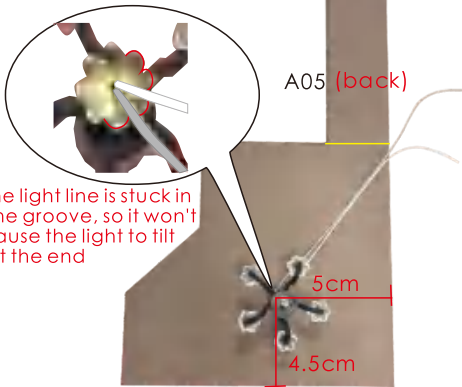

The light line is stuck in the groove, so it won't cause the light to tilt at the end

Mark the distance in the image and paste it (chandelier)
The light line is fixed to the yellow line and stops

8

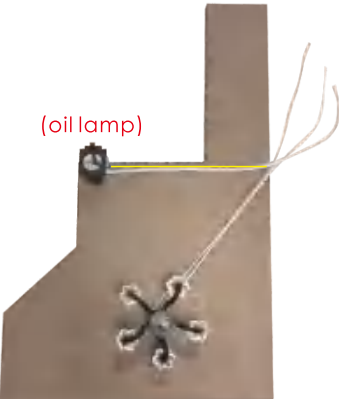

(oil lamp)

(Oil lamp) Just stick along the yellow line as shown in the picture

9



B01

paste

10



A05

paste

11



5

Install stairs

12

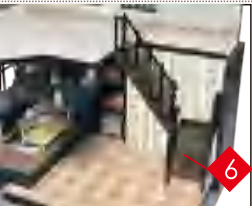

6

Install stairs

13



B03

B04

Install B03 and B04 as shown in the diagram

14



B02

Install B02 as shown in the diagram

15

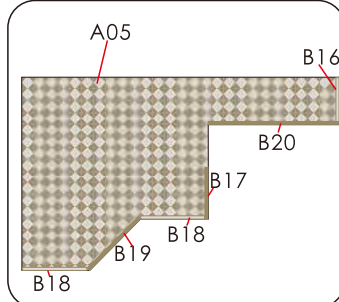

Display the effect of installing guardrails on the plane



B18

B19

B18

B17

16



B16

B20

Install and paste as shown in the picture

17



B10

B15

Install and paste B15 and B10 as shown in the picture

18



B13

Install and paste B13 as shown in the picture

19



B11

B14

Install and paste B11 and B14 as shown in the picture

20



Install and paste B12 as shown in the picture

21



(chrysanthemum)

3

(staging)

22

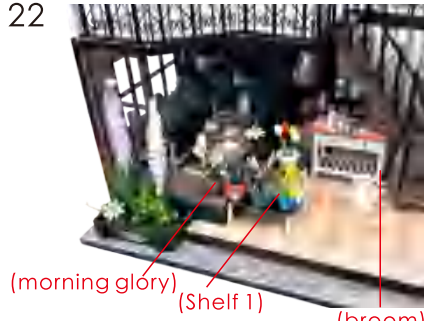

(morning glory)

(Shelf 1)

(broom)

23



(Shelf 2)(shovel)

4

24



Next, we will create the components for the second floor of the overall display diagram

Side table

Before production, first remove the wood particle board used in C15

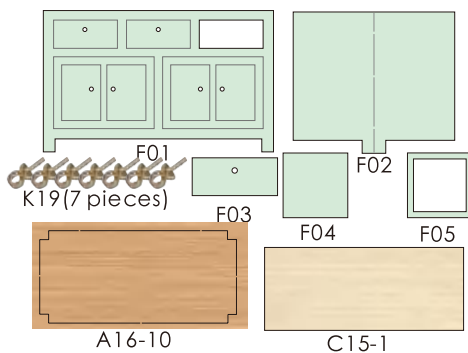

1

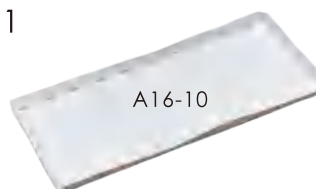

First, fold out the creases

2

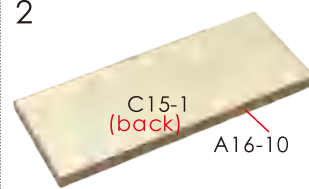

Place C15-1, fix and paste

3



(front)

4

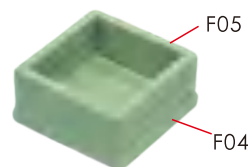

Fixed pasting

5



Fixed pasting

6



(drawer)

Insert fixed paste

7

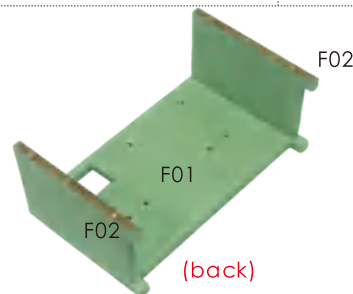

(back)

8

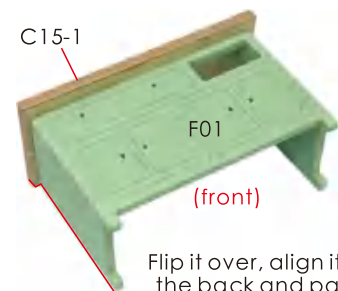

(front)

Flip it over, align it with the back and paste it

9



K19
Insert fixed paste

10



Arrange and fix the pasting as shown in the picture

Kettle

According to personal preferences, the following components can be selected for production



H07(1.5cm)
H07(1.5cm)

1



Fixed pasting

2



Insert fixed paste

3



H07(1.5cm)
Before production, bend H07 first

Lounge

Before production, cut out all the fabric materials and remove the wood particle board used in C15

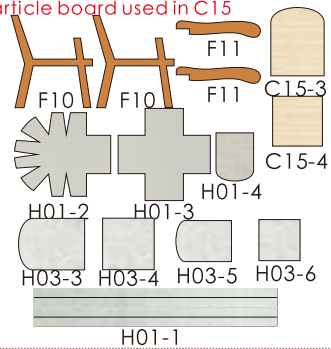

1

Paste in the order shown in the picture

2

Place and paste

3

Paste and fix around

4

Paste around the edges and then cut off excess fabric strips

5

Paste in the order shown in the picture

6

Paste and fix around

7

Place and paste

8

Paste around the edges and then cut off excess fabric strips

9

Align as shown in the picture, paste and fix it

10

Align as shown in the picture, paste and fix it

11

Paste and fix

Widget production

Before production, first cut out the wood particle boards of F06 and F07. You can choose the following components to make according to personal preferences

1

Place as shown in the picture, paste and fix it

2

Place as shown in the picture, paste and fix it

3

Place as shown in the picture, paste and fix it

4

The above methods are used to complete the color

5

Place as shown in the picture, paste and fix it

6

Paste as shown in the picture

7

Paste as shown in the picture

8

Paste as shown in the picture

Colorful flowers

According to personal preferences, the following components can be selected for production

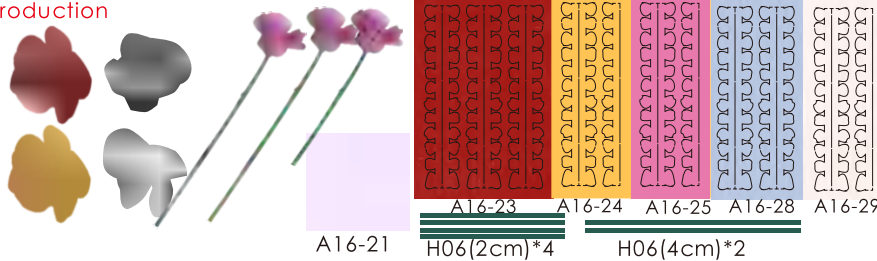

4

H06(2cm)*3

Three of them are inserted into H06 and pasted

5

A16-21

Fold in half as shown in the picture

6

Place, paste and fix as shown in the picture

1

A16-23

Use tweezers to clamp and roll up the paste

2

A16-23

Roll up fixed effect

3

A16-23

6 flowers need to be completed

10

(bouquet)

According to personal preferences, the following components can be selected for production

H06(3cm)

H06(3cm)

H06(2cm)

L01

A16-30

1

A16-30

H06

Paste A16-30 with different lengths of H06

2

L01

Thread into the light line

5

11

Install flowers

3

J01

Insert an appropriate amount of J01

4

Trimmed H06 inserted into the wood hole

Install the climbing vine

6

J01

Insert an appropriate amount of J01

7

12

Install flowers

8

11

9

12

Install as shown in the diagram, with the light wire threading out from the rear hole position

Install as shown in the diagram

According to personal preferences, the following components can be selected for production

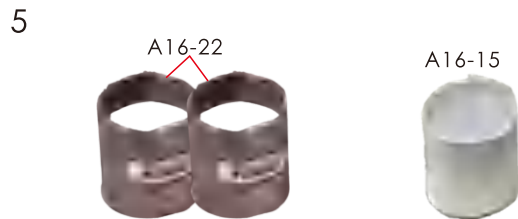
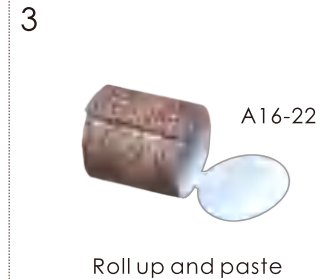
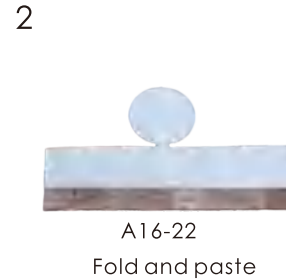
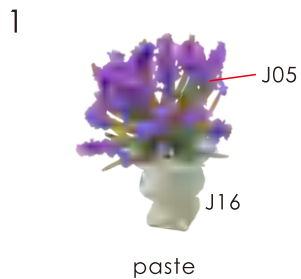

The above methods complete A16-22 and A16-15

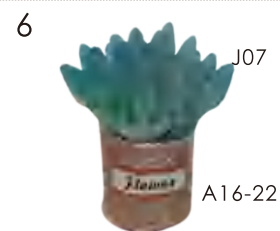

Place and paste as shown in the picture



J03 Crop the required size, place and paste

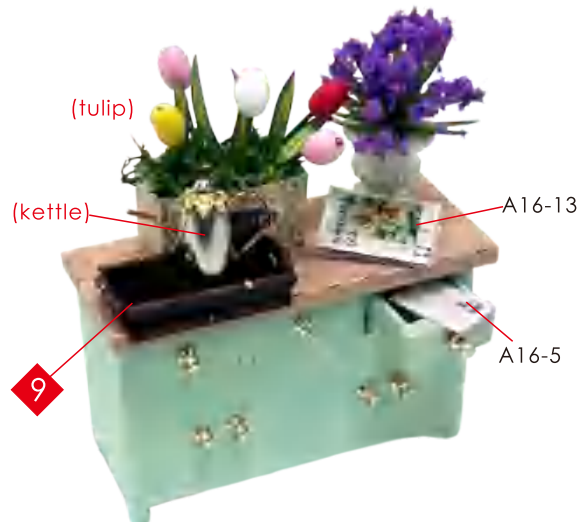

Parts can be placed according to personal preferences

According to personal preferences, the following components can be selected for production

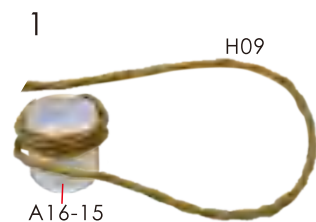
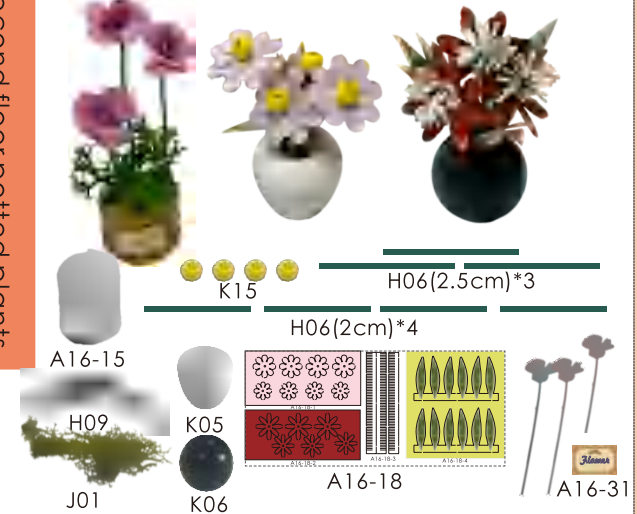

H09 pasted around A16-15

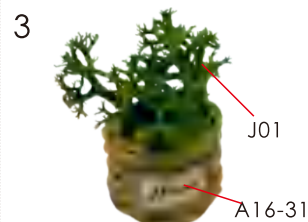

Insert an appropriate amount of J01

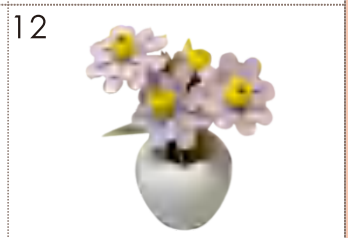
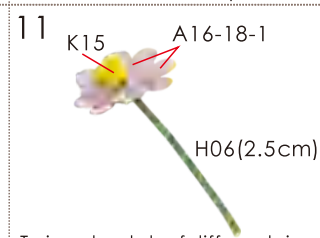
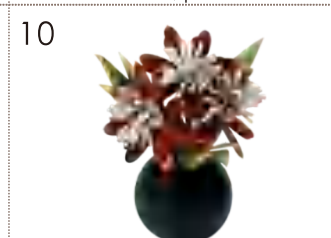
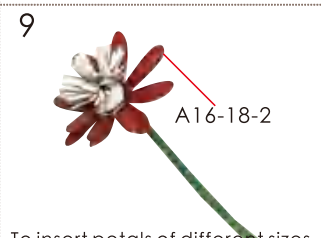
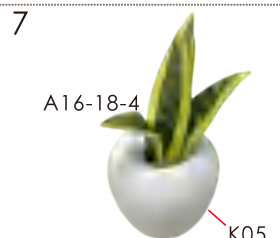
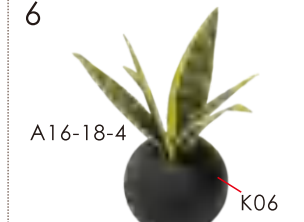

Second floor flower rack

Before production, first remove the G12 wood particle board



G06

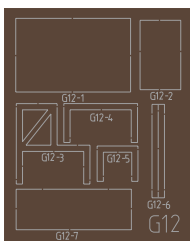

G12

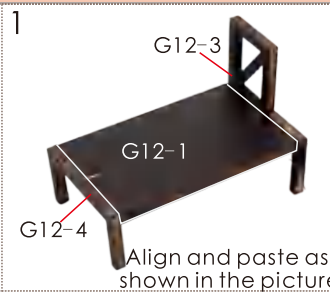

Align and paste as shown in the picture

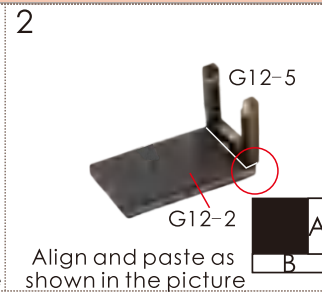

Align and paste as shown in the picture



(Flower rack 1)
Assemble and fix as shown in the picture

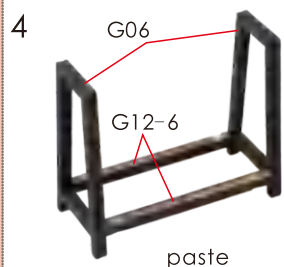

paste



(Flower rack 2)
Assemble and fix as shown in the picture



Parts can be placed according to personal preferences



Parts can be placed according to personal preferences

Second floor cabinet

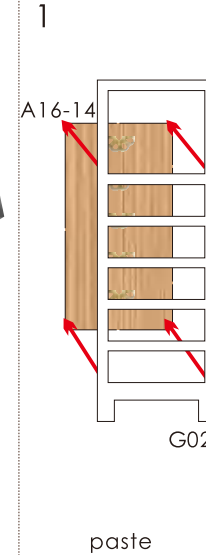

paste

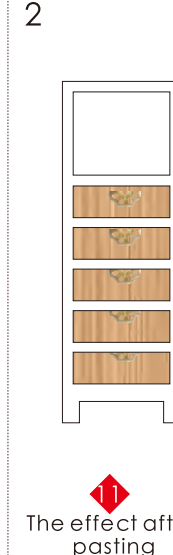

The effect after pasting

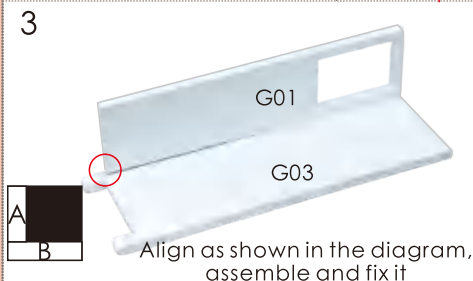

Align as shown in the diagram, assemble and fix it



Align as shown in the diagram, assemble and fix it

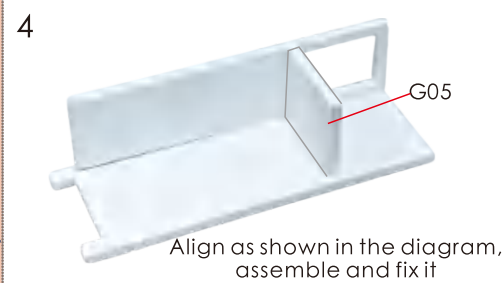

Align as shown in the diagram, assemble and fix it

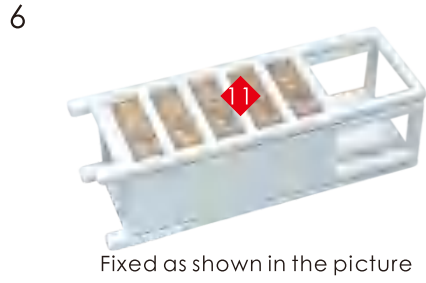

Fixed as shown in the picture



Fixed as shown in the picture



Parts can be placed according to personal preferences

Flower basket

Before production, first cut out the wood particle board of G09; According to personal preferences, the following components can be selected for production

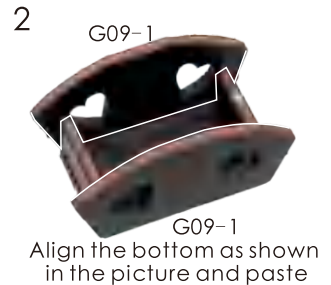
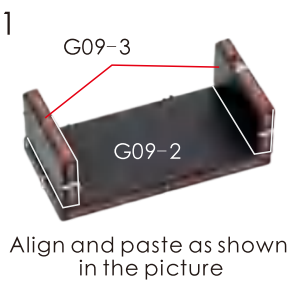
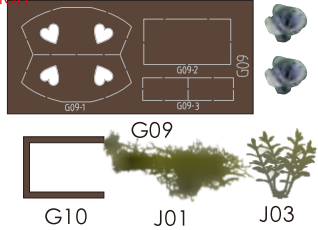

Sunflower

Before production, first remove the G11 wood particle board

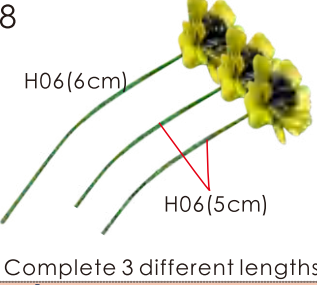
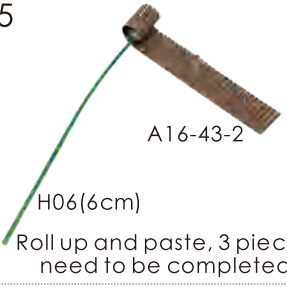
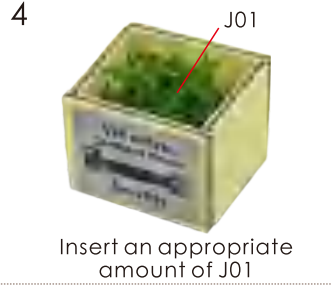
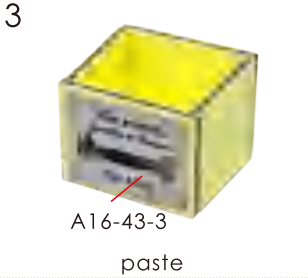
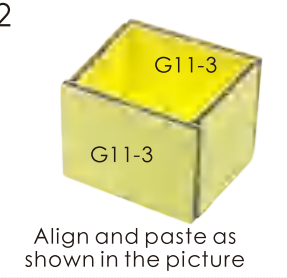
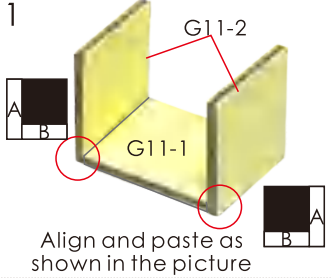
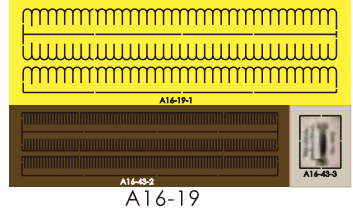
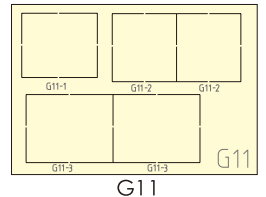

Green plants

According to personal preferences, the following components can be selected for production

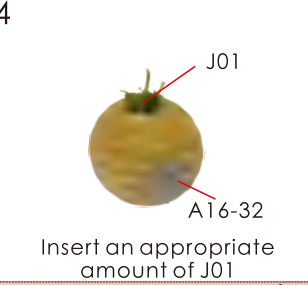
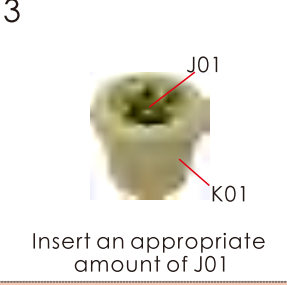
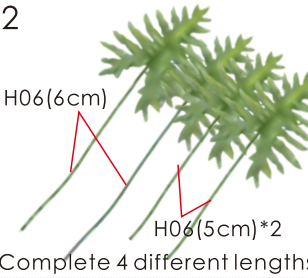
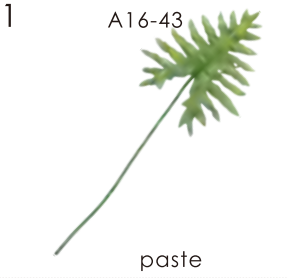
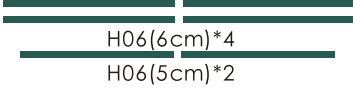
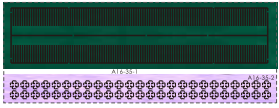
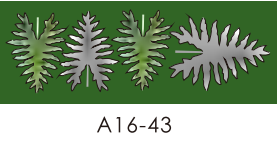

5



(Green Plant 1)

Insert and fix as shown in the picture

6

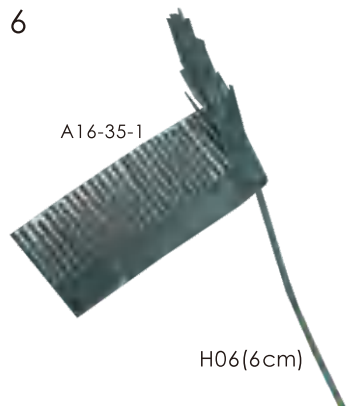

A16-35-1 wrapped around H06 and pasted

7



To organize the design, 2 sets need to be completed

8

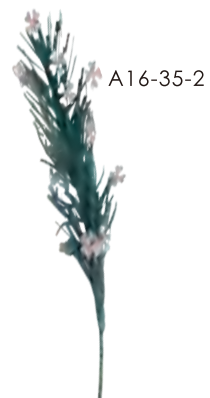

Apply an appropriate amount of A16-35-2

9



(Green Plant 2)
Insert and fix as shown in the picture

10

(Flower basket)



Place the components as shown in the diagram, fix and paste them

11

(Second floor cabinet)

(Cabinet)



Place the components as shown in the diagram, fix and paste them

12

(Green Plant 1)



Place the components as shown in the diagram, fix and paste them

13

(sunflower)



Place the components as shown in the diagram, fix and paste them

14

(Flower rack 1)



Place the components as shown in the diagram, fix and paste them

15

(Flower rack 2)
(Green Plant 2)

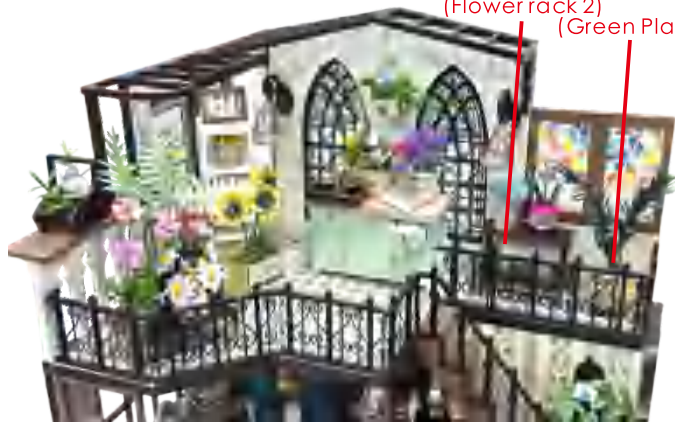

Place the components as shown in the diagram, fix and paste them

16

(lounge)



Place the components as shown in the diagram, fix and paste them

17

A16-44

A16-44

J02



Insert (chrysanthemum) as shown in the picture to add rich layers, paste A16-44 climbing vine on one side, and then paste an appropriate amount of J02

Tip: The pasting position can be freely adjusted~



Add colorful flowers on the green climbing vine as shown in the picture
Tip: The pasting position can be freely adjusted~

Lighting effect:



How to assemble the battery holder

Statement: the lamp wires cannot be inserted into the output socket.

- - Can use 2*AAA batteries
- - Please notice the place of anode and cathode when pit in the batteries
- - Rechargeable batteries are not blunt electricity
- - Rechargeable batteries can only be charged under adult supervision
- - Rechargeable batteries should be removed from the toy before charging
- - Different types of batteries cannot mix; Do not mix new batteries in use with semi-used batteries.
- - Run out of battery should be removed from the toy
- - The power shall not be short circuit

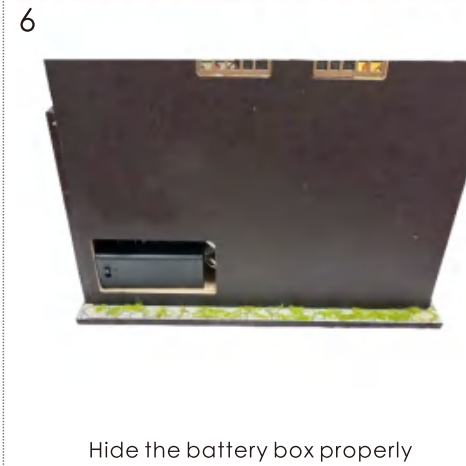
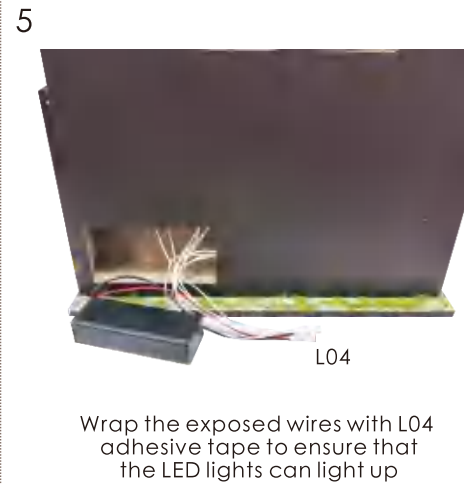
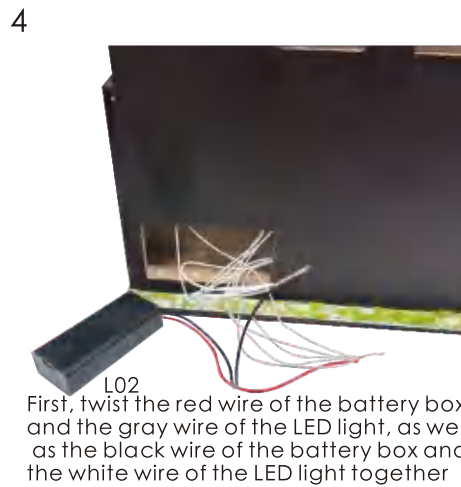
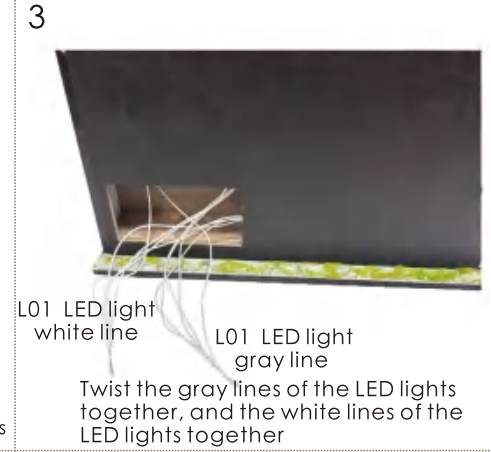
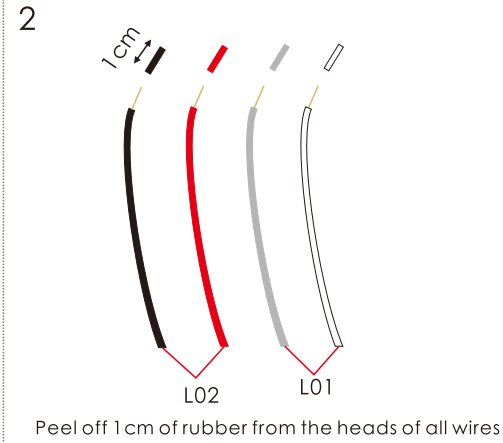
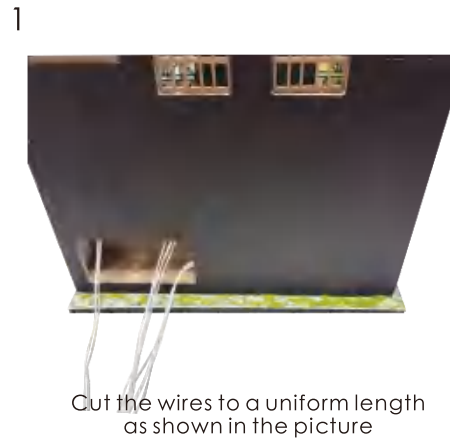



After assembly, the instruction manual should be retained